



BetttsHD[®]

Parts for the Long Haul[®]

SPRAY SUPPRESSION SOLUTIONS

POPULAR PARTS GUIDE

WINTER 2018





BettsHD[®]
Parts for the Long Haul[®]

SPRAY SUPPRESSION SOLUTIONS

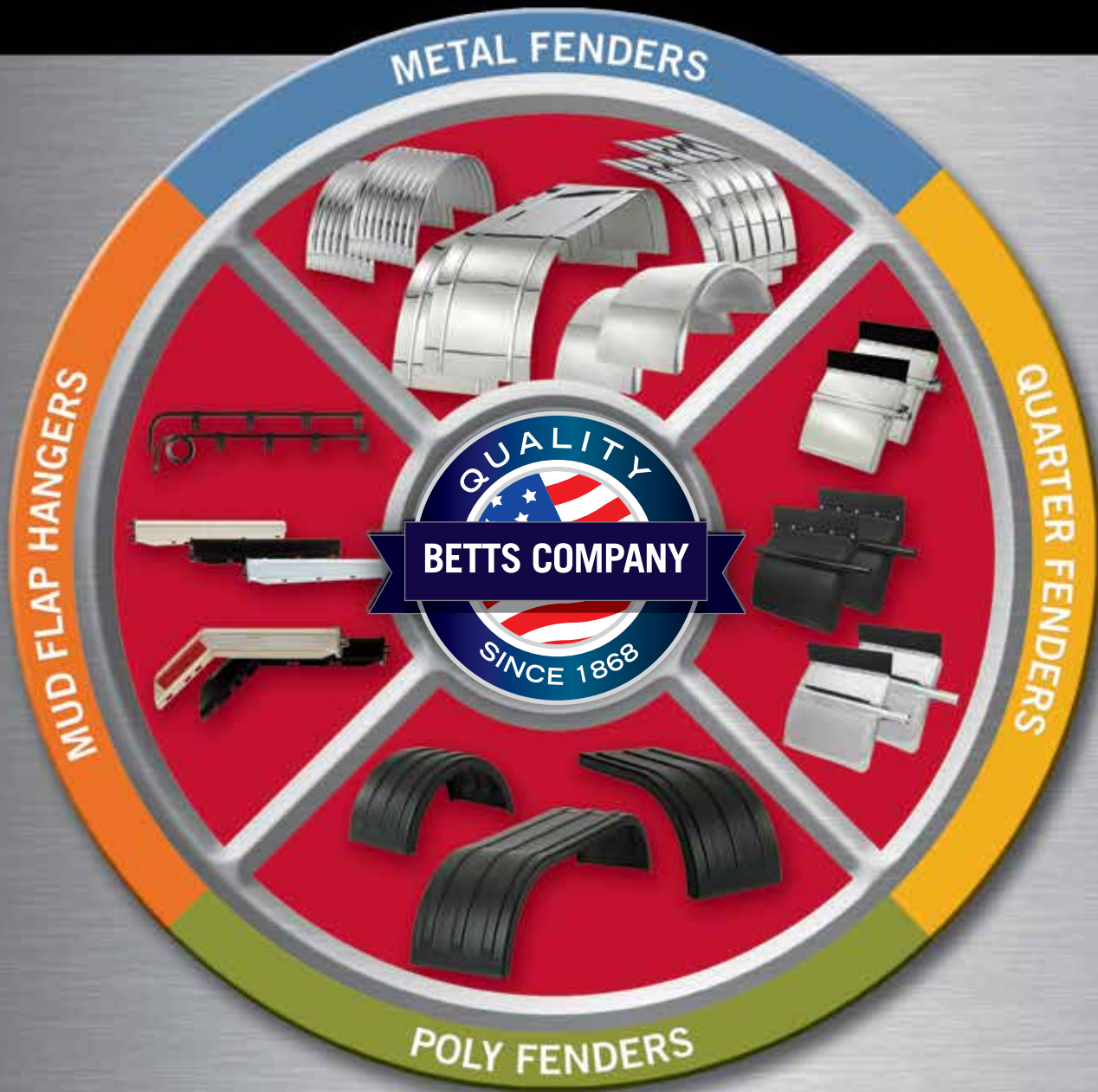

Your Single Source for Spray Suppression Solutions

Unparalleled Quality • Competitive Pricing • Made in the USA

Quality, Reliability, Value Intersect Here



BettsHD provides the most comprehensive selection of spray suppression products backed by exceptional delivery times and responsive customer service.

This easy-to-use guide

contains our most popular products in four product quadrants:

- Mud flap hangers
- Quarter fenders
- Poly fenders
- Metal Fenders

This is just a sampling of our value added products; to see all the options available through BettsHD, visit our interactive, dynamic online catalog at BettsHD.com. You'll find a full array of our products as well as custom design and manufacturing services.

If you don't see what you need, just ask – BettsHD is constantly developing and refining products, addressing customer needs and custom-designing new solutions. We continuously improve the range, quality and value of our product line, adding new products that are backed by focused marketing, extended customer support and streamlined business processes.

It's never been so easy to locate and order every one of our spray suppression products!

Why BettsHD?

Comprehensive product offering

Improving the Way Things Move® is part of everything we do – it is the foundation of who we are. Our range of products is tailored for heavy duty, over-the-road, municipal, intermodal, off-road, you name it, we've got it (or can design and make it!). Our product line breadth and depth is unparalleled – no other spray suppression supplier affords the depth of products offered by BettsHD.

Unequaled quality

Only BettsHD has invested in processes and systems to earn the highest level of quality certifications, including ISO 9001:2008. We've earned ultimate quality recognition from our customers, including Daimler Trucks North America and PACCAR. No other spray suppression provider can match our certifications or quality awards.

Dynamic new online catalog

Whether you want to check out the full breadth and depth of our product line or are interested in a single product for a particular application, you'll find our new online catalog was created just for you. Search by part type, orientation, material and other key product attributes.

Product Listing:

Bar Type Mud Flap Hangers / Straight	2
Bar Type Mud Flap Hangers / Angled Down	4
Bar Type Hanger Accessories	6
Conspicuity Solutions	7
Spring Loaded Mud Flap Hangers	8
DirectFlex® Mud Flap Retention System and TMF-RS	10
Quarter Fenders	12
Poly Fenders	14
Metal Fenders	16
Custom Products	20
SMART™ Part Numbering System	
Spring Loaded Mud Flap Hangers	22
Quarter Fenders	23
Fender Mounting Kits	24
Fender Mounting Tubes	24

BAR TYPE MUD FLAP HANGERS

STRAIGHT BAR



A25RL

- Heavy duty .640" square spring steel
- Nominal length - 29.750"
- Unhanded design fits left or right
- Individual mud flap hanger

HDetail

OUR BEST SELLING HANGER

BUY ONE OR A BARRELFUL

A25RLB40 BULK DISPLAY

- Attractive POP display barrel
- Heavy duty .640" square spring steel
- Nominal length - 29.750"
- Unhanded design fits left or right
- Barrel contains 40 A25RL mud flap hangers



A25RLB90 BULK DISPLAY

- Attractive POP display barrel
- Heavy duty .640" square spring steel
- Nominal length - 29.750"
- Unhanded design fits left or right
- Barrel contains 90 A25RL mud flap hangers

FEATURED PRODUCT

For the price-minded buyer, the BettsHD A25RL is the industry standard on virtually every truck manufactured in North America and without question the workhorse in the heavy-duty trucking world.

HDetail

ALL BETTSHD HANGERS ARE SHOT PEENED AND PAINTED TO ENSURE LONG LIFE.



HANGER KITS / UPGRADES

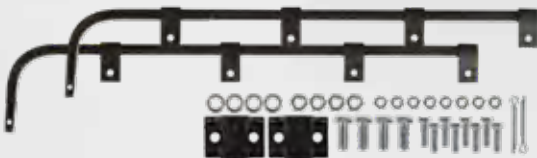

B25

- Heavy duty .640" square spring steel
- Nominal length - 29.750"
- Unhanded design fits left or right
- Boxed kit contains two (2) A25RL hangers, two (2) B711 mounting brackets and all mounting hardware



B82

- Extra heavy duty .750" square spring steel
- Nominal length - 29.750"
- Unhanded design fits left or right
- Boxed kit contains two (2) A82RL hangers, two (2) B700 mounting brackets and all mounting hardware

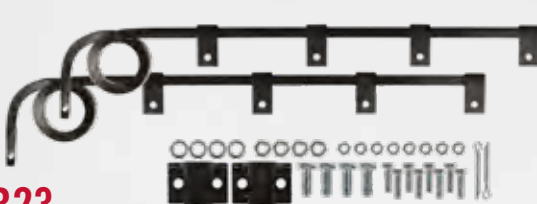

B23

- Heavy duty .640" square spring steel
- Nominal length - 29.750"
- Both left and right hand
- Boxed kit contains one (1) A23R and one (1) A23L hanger, two (2) B711 mounting brackets and all mounting hardware



B83

- Extra heavy duty .750" square spring steel
- Nominal length - 29.750"
- Both left and right hand
- Boxed kit contains one (1) A83R and one (1) A83L hangers, two (2) B700 mounting brackets and all mounting hardware

BAR TYPE MUD FLAP HANGERS

ANGLED DOWN

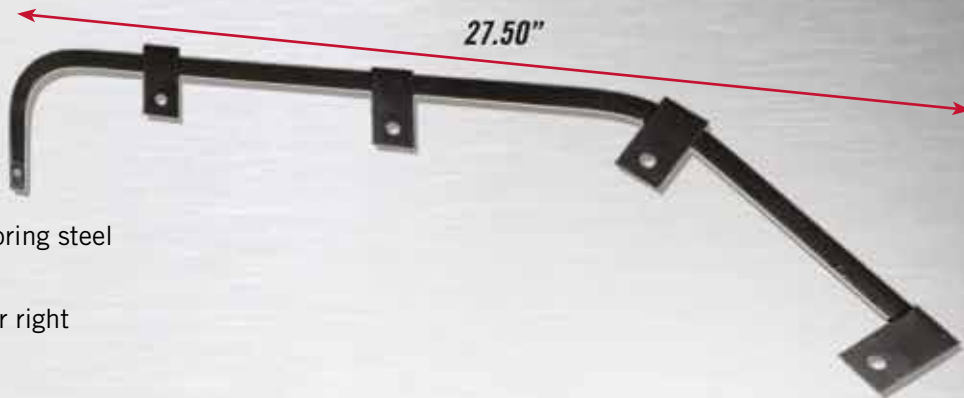

A35RL

- Heavy duty .640" square spring steel
- Nominal length - 27.500"
- Unhanded design fits left or right
- Individual mud flap hanger

BUY ONE OR A BARRELFUL

HDetail

INCREASE SHOWROOM PROFITS
WITH OUR "NEW AND IMPROVED"
BARREL DESIGN.

A35RLB40 BULK DISPLAY

- Attractive POP display barrel
- Heavy duty .640" square spring steel
- Nominal length - 27.500"
- Unhanded design fits left or right
- Barrel contains 40 A35RL mud flap hangers



A35RLB80 BULK DISPLAY

- Attractive POP display barrel
- Heavy duty .640" square spring steel
- Nominal length - 27.500"
- Unhanded design fits left or right
- Barrel contains 80 A35RL mud flap hangers

FEATURED PRODUCT

City streets, tight turns, uneven road surfaces, short frames, sliding fifth wheels and other issues presented BettsHD engineers with plenty of application design opportunities. Simple and effective; shorter, angled hangers, like the A35RL, get the job done.



HANGER KITS / UPGRADES

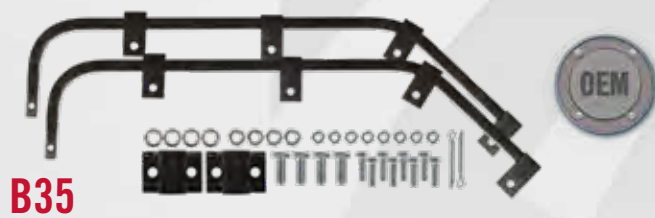

B35

- Heavy duty .640" square spring steel
- Nominal length - 27.500"
- Unhanded design fits left or right
- Boxed kit contains two (2) A35RL hangers, two (2) B711 mounting brackets and all mounting hardware

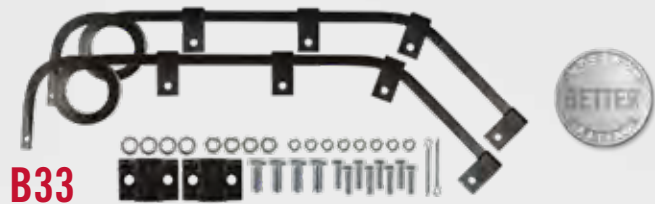

B33

- Heavy duty .640" square spring steel
- Nominal length - 27.625"
- Both left and right hand
- Boxed kit contains one (1) A33R and one (1) A33L hanger, two (2) B711 mounting brackets and all mounting hardware

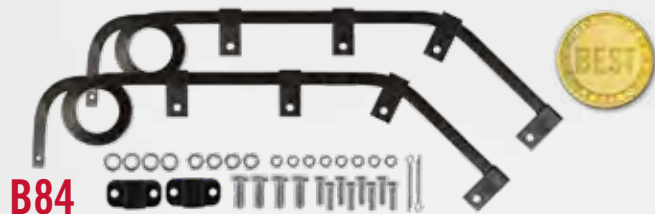

B84

- Extra heavy duty .750" square spring steel
- Nominal length - 27.750"
- Both left and right hand
- Boxed kit contains one (1) A84R and one (1) A84L hanger, two (2) B700 mounting brackets and all mounting hardware

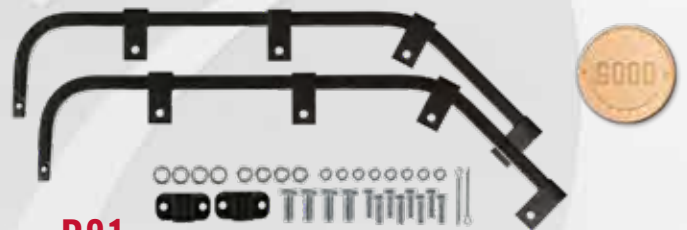

B81

- Extra heavy duty .750" square spring steel
- Nominal length - 27.500"
- Unhanded design fits left or right
- Boxed kit contains two (2) A81RL hangers, two (2) B700 mounting brackets and all mounting hardware

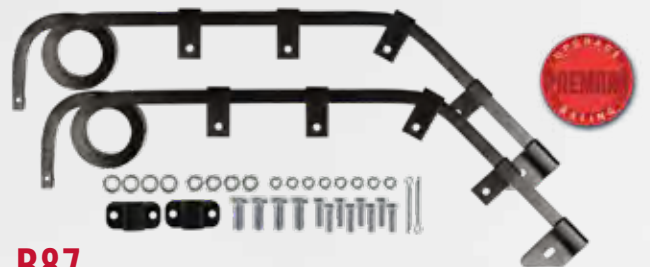

B87

- Extra heavy duty .750" square spring steel
- Nominal length - 30.500"
- Both left and right hand
- Boxed kit contains one (1) A87R and one (1) A87L hanger, two (2) B700 mounting brackets and all mounting hardware



HDetail

A87 HANGERS INCORPORATE AN ANTI-TEAR END CLIP INTO AN ALREADY STURDY DESIGN.

BAR TYPE HANGER ACCESSORIES

MOUNTING KITS

B516P Mud Flap Mounting Kit POP Display

- Attractive and convenient counter display pail
- Pail contains 50 individually packaged kits of nuts, bolts and washers
- Each kit installs one mud flap



B711P Bar Type Hanger Mounting Bracket POP Display

- Attractive and convenient counter display pail
- Pail contains 20 individual B711 mounting brackets



HDetail

ALL BETTSHD MOUNTING BRACKETS ARE PREMIUM QUALITY CAST STEEL, ONE-PIECE CONSTRUCTION; AVAILABLE INDIVIDUALLY OR IN BOXED PAIRS WITH MOUNTING HARDWARE.

MOUNTING BRACKETS

B711 Individual K711 Boxed Pair with Mounting Hardware

- Nominal inside dimension - 0.640"
- Mounting hole centers - 1.875"
- Mounting hole orientation - horizontal
- Nominal overall width - 2.875" / height - 2.000"



B700 Individual K700 Boxed Pair with Mounting Hardware

- Nominal inside dimension - 0.750"
- Mounting hole centers - 2.875"
- Mounting hole orientation - horizontal
- Nominal overall width - 4.000" / height - 2.000"



B1732 Individual K1732 Boxed Pair with Mounting Hardware

- Nominal inside dimension - 0.640"
- Mounting hole centers - 2.875"
- Mounting hole orientation - horizontal
- Nominal overall width - 4.625" / height - 2.000"



B850 Individual K850 Boxed Pair with Mounting Hardware

- Nominal inside dimension - 0.750"
- Mounting hole centers - 3.313"
- Mounting hole orientation - vertical
- Nominal overall width - 1.750" / height - 4.625"



CONSPICUITY SOLUTIONS

RTR105

Size: 2" x 150' (roll)
Color(s): 11" Red, 7" White

RTR205

Size: 2" x 150' (roll)
Color(s): 6" Red, 6" White

RTR305

Size: 2" x 150' (roll)
Color(s): White



RT25

- Lightweight aluminum construction
- Use with straight bar or spring loaded hangers
- Unhanded design fits both left and right
- Skin card display packaging
- Contains two (2) RT25RL conspicuity strips
- Can be ordered individually, unpackaged (RT25RL)

RT25RL



- Lightweight aluminum construction
- Use with straight bar or spring loaded hangers
- Unhanded design fits both left and right
- Individual, unpackaged



RT35

- Lightweight aluminum construction
- Use with angled bar or spring loaded hangers
- Both left and right
- Skin card display packaging
- Contains one (1) RT35R and one (1) RT35L conspicuity strip
- Can be ordered individually, unpackaged (RT35R or RT35L)

BHDPL-24

BettsHD Display for Conspicuity Solutions easily displays RT25's and RT35's

Contact your salesperson to customize this display.



RT35L

- Lightweight aluminum construction
- Use with angled bar or spring loaded hangers
- Individual, unpackaged

RT35R

- Lightweight aluminum construction
- Use with angled bar or spring loaded hangers
- Individual, unpackaged

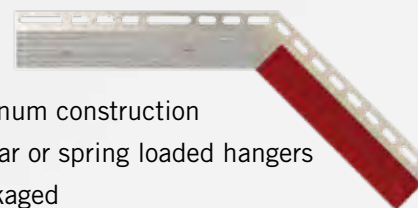

SPRING LOADED MUD FLAP HANGERS

STRAIGHT

B573025WTBK

- Mounting stud centers - 1.125"
- Nominal length - 30.250"
- Powder coated carbon steel
- Both left and right hand
- Boxed kit includes (1) LH and (1) RH hanger, stud nuts and mud flap mounting hardware

SMART™

PART NUMBERING SYSTEM
SEE PAGE 22



HDetail

ADDITIONAL OPTIONS

- > STAINLESS STEEL
- > WITH OR WITHOUT CONSPICUITY TAPE
- > 25" OR 28" LENGTHS
- > 2.500" MOUNTING CENTERS
- > INDIVIDUAL PACKAGING



TAPERED

B703000NTSK

- Mounting stud centers - 2.500"
- Nominal length - 30.000"
- Bright 430 stainless steel
- Both left and right hand
- Boxed kit includes (1) LH and (1) RH hanger, stud nuts and mud flap mounting hardware



HDetail

ADDITIONAL OPTIONS

- > BLACK POWDER COATED CARBON STEEL AND CHROME
- > WITH OR WITHOUT CONSPICUITY STRIP
- > 33" LENGTH
- > 1.125" MOUNTING CENTERS
- > INDIVIDUAL PACKAGING



SPRING LOADED MUD FLAP HANGERS FEATURES

Superior appearance, workhorse performance; BettsHD spring loaded mud flap hangers are designed with truckers in mind. Straight and angled designs available in three lengths and two mounting stud centers solve most installations. Our industry exclusive open wound coil spring design reduces corrosion, while the self-centering tombstone ensures positive alignment. And if this is not enough, our optionally integrated conspicuity tape reduces cost and keeps you compliant.

Open Wound Coil Spring

Proprietary Design
Corrosion Resistant
Unrivaled Spring Recovery
Unparalleled Spring Yield Performance



Integrated Self-Centering Tombstone

Maximum Horizontal Deflection
Frame Protection



ANGLED

B673025WTBK

- Mounting stud centers - 1.125"
- Nominal length - 30.250"
- Powder coated carbon steel
- Both left and right hand
- Boxed kit includes (1) LH and (1) RH hanger, stud nuts and mud flap mounting hardware



B672625NTBK

- Mounting stud centers - 1.125"
- Nominal length - 26.250"
- Powder coated carbon steel
- Unhanded design fits both left and right
- Boxed kit includes (1) LH and (1) RH hanger, stud nuts and mud flap mounting hardware



DIRECTFLEX[®] MUD FLAP RETENTION

STRAIGHT ARM

DF25PB941

- Mounting hole centers - 1.125", 2.500" and 3.313"
- Mounting hole orientation - vertical
- Nominal length - 30.250"
- Powder coated high carbon spring steel
- Both left and right hand
- Boxed kit includes (1) LH and (1) RH hanger, and frame mounting hardware

HDetail

ADDITIONAL OPTIONS

- > 1.875" AND 2.875" MOUNTING CENTERS WITH HORIZONTAL ORIENTATION.



ANGLED ARM

DF3526PB941

- Mounting hole centers - 1.125", 2.500" and 3.313"
- Mounting hole orientation - vertical
- Nominal length - 25.750"
- Powder coated high carbon spring steel
- Both left and right hand
- Boxed kit includes (1) LH and (1) RH hanger, and frame mounting hardware

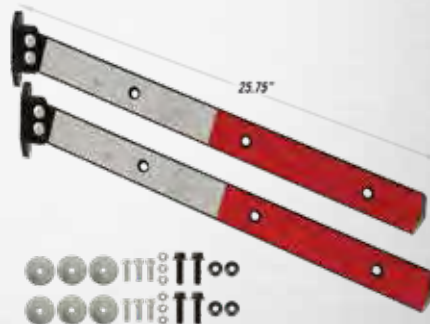

TRAILER MUD FLAP RETENTION SYSTEM (TMF-RS)

TRSD10NT

Trailer Mud Flap Retention System with DirectFlex[®]

- Conspicuity: Without
- Slider Width: 48"
- Handedness: Pair
- Durability: Severe Duty Premium



TRSD10WT

Trailer Mud Flap Retention System with DirectFlex[®]

- Conspicuity: With
- Slider Width: 48"
- Handedness: Pair
- Durability: Severe Duty Premium



TRSB10NT

Trailer Mud Flap Retention System Spring Loaded Hangers

- Conspicuity: Without
- Slider Width: 48"
- Handedness: Pair
- Durability: Heavy Duty Standard



TRSB10WT

Trailer Mud Flap Retention System Spring Loaded Hangers

- Conspicuity: With
- Slider Width: 48"
- Handedness: Pair
- Durability: Heavy Duty Standard



FEATURED PRODUCT

In 1999, BettsHD introduced the only patented mud flap retention system; no moving components render the system near maintenance free and three (3) mounting bracket options accommodate all popular installation configurations. The DirectFlex® Mud Flap Retention System. It's what fleets have been demanding!



CHANNELFLAP™

CF3526LH24PB

- Angled / corner cut
- 24" long
- Left hand
- Individual mud flap

HDdetail

ADDITIONAL OPTIONS
> 30" LENGTH

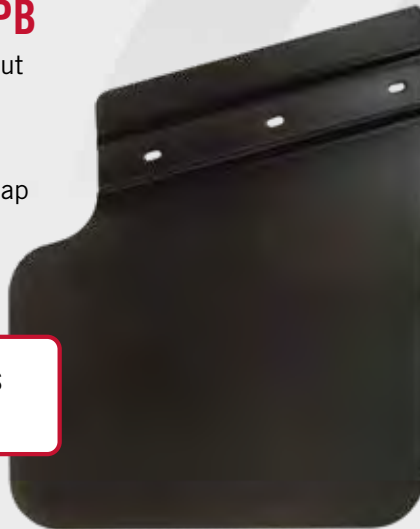

CF3526RH24PB

- Angled / corner cut
- 24" long
- Right hand
- Individual mud flap

HDdetail

ADDITIONAL OPTIONS
> 30" LENGTH



CF25RL30PB

- Straight / full width
- 30" long
- Unhanded design fits both left and right
- Individual mud flap

HDdetail

ADDITIONAL OPTIONS
> 24" LENGTH



HDdetail

THE CHANNELFLAP™ HEAVY-DUTY POLY MUD FLAP ENCAPSULATES THE DIRECTFLEX® HANGER.

THIS CREATES A COMPRESSION FIT BETWEEN THE COMPONENTS RESULTING IN A MINIMUM **3X STRONGER** CONNECTION WHEN COMPARED TO ANY TRADITIONAL MUD FLAP AND MUD FLAP HANGER COMBINATION.

QUARTER FENDERS

POLY

PS211PA2

- Standard mount
- Black UV resistant poly panel
- Black, e-coat, 18-gauge carbon steel mounting tube
- AccuSeal aluminized carbon steel tube clamp
- Black poly top flat with zinc plated steel top flap hardware
- Fully assembled box kit, includes both mounting clamps, top flaps and top flap mounting hardware



PS221PA2

- Low mount



HDdetail

NO OTHER QUARTER FENDER OFFERS ANTI-SPRAY PROTECTION, DESIGNED WEIGHT REDUCTION, FLEXIBLE INSTALLATION OPTIONS AND AN EASY TO INSTALL MOUNTING CLAMP THAT ACTUALLY WORKS.

SMART[™]

PART NUMBERING SYSTEM
SEE PAGE 23

STAINLESS

SS211PA2

- Standard mount
- Bright 430 18-gauge stainless steel panel and mounting tube
- AccuSeal stainless steel tube clamp
- Black poly top flap, plain no logo and stainless steel top flap hardware
- Fully assembled box kit, includes both mounting clamps, top flaps and top flap mounting hardware



SS221PA2

- Low mount



SS241PA2

- Ultra low mount



LIKE IT? CUSTOMIZE IT!

SEE PAGE 21 FOR CUSTOM OPTIONS

FEATURED PRODUCT

One word describes BettsHD's array of quarter fenders – IMPRESSIVE! BettsHD quarter fenders are manufactured from a wide variety of materials to satisfy your specific application: Aluminum, powder coated carbon steel, stainless steel and poly. Packaged mounting options include the popular one-bolt post, four-bolt or weld-on flange post and crossovers.



ACCESSORIES

X2900

- Single bolt post
- Eight inches (8") long
- Packaged individually



400118-01

- AccuSeal stainless steel tube clamp
- BettsHD exclusive
- For stainless steel and aluminum quarter fenders
- Use 400118-00 aluminized version for galvanized mounting tubes



TOP FLAPS

- Popular stock logos available: eagle, flame and longhorn
- Custom logos available; minimum quantity applies



HDetail

BETTSHD TOP FLAPS REQUIRE 25% MORE HARDWARE TO BE INSTALLED. WE HAVEN'T FOUND ONE COMPETITOR USING FIVE ATTACHMENT POINTS LIKE WE DO, BUT THEN AGAIN WE HAVEN'T FOUND ONE WILLING TO BACK THEIR QUARTER FENDERS WITH A LIMITED LIFETIME WARRANTY EITHER.



LIKE IT? CUSTOMIZE IT!
SEE PAGE 21 FOR CUSTOM OPTIONS

POLY FENDERS

SINGLE AXLE

PF200-68

- Black high density UV resistant poly
- 3-Rib Up with radiused edge
- Overall length - 68"
- Fender opening - 46" / wheel size - 22.5" and 24.5" / application - dual wheels
- Cardboard wrapped pair
- K2363UG fender mounting kit recommended, not included

1 NUMBER ORDERING

PF200-68 + K2363UG =
TIKPF200-68P



LIKE IT? CUSTOMIZE IT!

SEE PAGE 21 FOR CUSTOM OPTIONS



HDdetail

ADDITIONAL OPTIONS
> 80" OVERALL LENGTH
> 16.5" AND 19.5" WHEEL SIZES

HALF TANDEM AXLE

PF300-66

- Black high density UV resistant poly
- 3-Rib Up with radiused edge
- Overall length - 66" / front curve - 39" / flat section - 27"
- Fender opening - 51" / wheel size - 22.5" and 24.5" / application - dual wheels
- Cardboard wrapped pair
- K3363UG fender mounting kit recommended, not included

1 NUMBER ORDERING

PF300-66 + K3363UG =
TIKPF300-66P



HDdetail

ADDITIONAL OPTIONS
> 57" OVERALL LENGTH

FULL TANDEM AXLE

PF400-132X

- Black high density UV resistant polyethylene
- 3-Rib Up with radiused edge
- Overall length - 132" / front curve - 39" / flat section - 54" / rear curve - 39"
- Fender opening - 105" / wheel size - 22.5" and 24.5" / application - dual wheels
- Cardboard wrapped pair
- K4363UG fender mounting kit recommended, not included

1 NUMBER ORDERING

PF400-132X + K4363UG =
TIKPF400-132XP



HDdetail

ADDITIONAL OPTIONS
> 114" OVERALL LENGTH

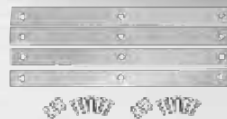

FEATURED PRODUCT

Popular single, half and full tandem axle poly fenders ideally suited for desirable lightweight installations are supplied from stock by BettsHD. Our modular design allows for "Build-A-Fender" solutions – on the spot!



SMART™

**PART NUMBERING SYSTEM
SEE PAGE 24**

ACCESSORIES / MOUNTING KITS

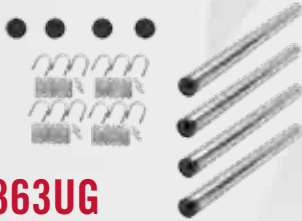

K2363UG

- Four (4) T363UG single-bolt frame mount, undrilled galvanized tubes
- Four (4) P100H-1 galvanized U-bolt hardware kits: each contains three (3) U-bolts, lock nuts and washer plates
- Four (4) CP12 poly end caps



K3363UG

- Two (2) T363UG single-bolt frame mount, undrilled galvanized tubes
- Two (2) P100H-1 galvanized U-bolt hardware kits: each contains three (3) U-bolts, lock nuts and washer plates
- Two (2) CP12 poly end caps
- Two (2) B900G single-bolt frame mounts, .625" through-hole with 3½" vertical adjustability
- Two (2) B4H-1: each contains five (5) carriage bolts, nuts, flat and lock washers



K4363UG

- Four (4) T363UG single-bolt frame mount, undrilled galvanized tubes
- Four (4) P100H-1 galvanized U-bolt hardware kits: each contains three (3) U-bolts, lock nuts and washer plates
- Four (4) CP12 poly end caps
- Two (2) B900G single-bolt frame mounts, .625" through-hole with 3½" vertical adjustability
- Two (2) B4H-1: each contains five (5) carriage bolts, nuts, flat and lock washers

PF400H-1



- Cap screw and strap kit
- Connects poly fender sections
- Galvanized steel

POLY MODULAR SECTIONS

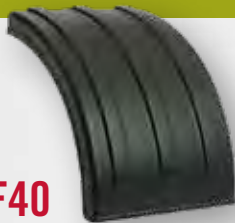

PF40

- Black high density UV resistant poly
- Front or rear curve for modular configuration
- Overall length - 40"

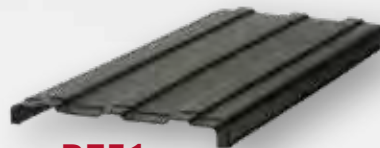

PF51

- Black high density UV resistant poly
- Flat poly section
- Overall length - 51"

HDetail

**TANKER APPLICATIONS
ARE A 'SNAP' WITH
BETTSHD POLY FENDERS.**



P4H-1

- Carriage bolt hardware kit
- Connects PF40 and PF51 fender sections
- Zinc plated steel

METAL FENDERS



LIKE IT? CUSTOMIZE IT!

SEE PAGE 20 FOR CUSTOM OPTIONS

SINGLE AXLE

SR200-80

- Bright 430 18 gauge stainless steel
- 4-Rib with beaded edge
- Overall length - 80"
- Fender opening - 50" / wheel size - 22.5" and 24.5" / application - dual wheels
- Cardboard wrapped pair
- K2362PS fender mounting kit recommended, not included



HDetail

ADDITIONAL OPTIONS

- > 60" OVERALL LENGTHS
- > GALVANIZED CARBON STEEL OR ALUMINUM

HALF TANDEM AXLE

1 NUMBER ORDERING

SR300-66 + K3362PS =
TIKSR300-66DS

SR300-66

- Bright 430 18 gauge stainless steel
- 4-Rib with beaded edge
- Overall length - 66" / front curve - 39" / flat section - 27"
- Fender opening - 51" / wheel size - 22.5" and 24.5" / application - dual wheels
- Cardboard wrapped pair with SF100H rubber vibration isolators
- K3362PS fender mounting kit recommended, not included



HDetail

ADDITIONAL OPTIONS

- > 60" AND 80" OVERALL LENGTHS
- > GALVANIZED CARBON STEEL OR ALUMINUM

FULL TANDEM AXLE

1 NUMBER ORDERING

SR400-126 + K4362PS =
TIKSR400-126DS

SR400-126

- Bright 430 18 gauge stainless steel
- 4-Rib with beaded edge
- Overall length - 126" / front curve - 39" / flat section - 54" / rear curve - 33"
- Fender opening - 104" / wheel size - 22.5" and 24.5" / application - dual wheels
- Cardboard wrapped pair with SF100H rubber vibration isolators
- K4362PS fender mounting kit recommended, not included



HDetail

ADDITIONAL OPTIONS

- > 105", 120" & 132" OVERALL LENGTHS
- > GALVANIZED CARBON STEEL OR ALUMINUM

FEATURED PRODUCT

Only BettsHD offers a full range of fender options to comprehensively serve fleet requirements including single, half and full tandem applications. Choose from aluminum, galvanized carbon or stainless steel materials. When it comes to style choose from the industry standard 4-Rib or BettsHD exclusives: corrugated and 2-Rib! Don't forget, we also offer permanently etched, personalized monogramming on our beautiful stainless steel 2-Rib styling.



ACCESSORIES / MOUNTING KITS



K2362PS

- Four (4) T362PS single-bolt frame mounts, predrilled stainless steel tubes
- Four (4) B4HS-1 stainless steel carriage bolt kits: each contains five (5) carriage bolts, nuts, flat and lock washers
- Four (4) CP12 poly end caps



K3362PS

- Two (2) T362PS single-bolt frame mounts, predrilled stainless steel tubes
- Four (4) B4HS-1 stainless steel carriage bolt kits: each contains five (5) carriage bolts, nuts, flat and lock washers
- Two (2) CP12 poly end caps
- Two (2) B900S single-bolt frame mounts, .625" through-hole with 3½" vertical adjustability



K4362PS

- Four (4) T362PS single-bolt frame mounts, predrilled stainless steel tubes
- Six (6) B4HS-1 stainless steel carriage bolt kits: each contains five (5) carriage bolts, nuts, flat and lock washers
- Four (4) CP12 poly end caps
- Two (2) B900S single-bolt frame mounts, .625" through-hole with 3½" vertical adjustability



B900S

- Single-bolt frame mount, .625" through-hole with 3½" vertical adjustability
- Unhanded design fits left or right
- Black e-coated carbon steel
- One (1) B4HS-1 stainless steel carriage bolt kit: each contains five (5) carriage bolts, nuts, flat and lock washers

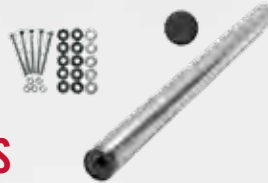

T362US

- Single-bolt frame mount, .625" through hole, undrilled stainless steel tube
- Bright 430 12 gauge stainless steel
- Overall length - 30"
- One (1) B4HS-1 stainless steel carriage bolt kit: each contains five (5) carriage bolts, nuts, flat and lock washers
- CP12 poly end cap

SMART™

**PART NUMBERING SYSTEM
SEE PAGE 24**

HDetail

ADDITIONAL OPTIONS
 > 26.5" OVERALL LENGTH
 > .725" MOUNTING HOLE
 > FOUR (4) U-BOLTS

SMOOTH STAINLESS FENDERS

SINGLE AXLE

1 NUMBER ORDERING

TS2800000 + L200TS =
TIKT800000

TS2800000

- Bright 430 16 gauge stainless steel
- Smooth with radiused edge
- Overall length – 80"
- Fender opening – 50" / wheel size – 22.5" and 24.5" / application – dual wheels
- Cardboard wrapped pair
- L200TS fender mounting kit recommended, not included



HALF TANDEM AXLE

1 NUMBER ORDERING

TS33902700 + U300TS =
TIKT392700

TS33902700

- Bright 430 16 gauge stainless steel
- Smooth with radiused edge
- Overall length – 66" / front curve - 39" / flat section - 27"
- Fender opening – 51" / wheel size – 22.5" and 24.5" / application – dual wheels
- Cardboard wrapped pair with SF200H rubber vibration isolators
- U300TS fender mounting kit recommended, not included



HDetail

ADDITIONAL OPTIONS

> 66" OVERALL LENGTH WITH 35" FRONT CURVE AND 31" FLAT SECTION

FULL TANDEM AXLE

1 NUMBER ORDERING

TS43905439 + U400TS =
TIKT395439

TS43905439

- Bright 430 16 gauge stainless steel
- Smooth with radiused edge
- Overall length – 132" / front curve - 39" / flat section - 54" / rear curve - 39"
- Fender opening – 105" / wheel size – 22.5" and 24.5" / application – dual wheels
- Cardboard wrapped pair with SF200H rubber vibration isolators
- U400TS fender mounting kit recommended, not included



HDetail

ADDITIONAL OPTIONS

> 120" OVERALL LENGTH

FEATURED PRODUCT

Manufactured using bright 430 16 gauge stainless steel for durability, our smooth stainless steel fenders provide a premium design finish enhancing any truck or fleet image. Our smooth stainless steel fenders feature a 24" width for extra spray suppression and a sleek 1½" flange for added strength.



L200TS

- Four (4) B610TS stainless steel paddle brackets
- Four (4) TSG100-1 mounting template/gaskets
- Four (4) TS100H-1 hardware kits: each kit contains three (3) strap plates, six (6) cap screws and six (6) flat washers
- Four (4) 400118-01 AccuSeal stainless steel clamps
- Four (4) X2900 single-bolt posts



U300TS

- Two (2) B610TS stainless steel paddle brackets
- Two (2) TSG100-1 mounting template/gaskets
- Two (2) TS100H-1 hardware kits: each kit contains three (3) strap plates, six (6) cap screws and six (6) flat washers
- Two (2) B900S single-bolt frame mounts, .625" through-hole with 3-½" vertical adjustability
- Two (2) B4HS-1 stainless steel carriage bolt kits: each contains five (5) carriage bolts, nuts, flat and lock washers
- Two (2) 400118-01 AccuSeal stainless steel clamps
- Two (2) X2900 single-bolt posts



U400TS

- Four (4) B610TS stainless steel paddle brackets
- Four (4) TSG100-1 mounting template/gaskets
- Four (4) TS100H-1 hardware kits: each kit contains three (3) strap plates, six (6) cap screws and six (6) flat washers
- Two (2) B900S single-bolt frame mounts, .625" through-hole with 3-½" vertical adjustability
- Two (2) B4HS-1 stainless steel carriage bolt kits: each contains five (5) carriage bolts, nuts, flat and lock washers
- Four (4) 400118-01 AccuSeal stainless steel clamps
- Four (4) X2900 single-bolt posts

SPECIALTY FENDERS



TS80100141

- Bright 430 16 gauge stainless steel
- Smooth with radiused edge
- Overall length – 38"
- Fender opening – 35-½" / wheel size – 22.5" and 24.5" / application – Rogue and Superior Trailer
- Cardboard wrapped pair



TS80100139

- Bright 430 16 gauge stainless steel
- Smooth with radiused edge
- Overall length – 48-½"
- Fender opening – 42" / wheel size – 22.5" and 24.5" / application – Reliance Trailer
- Cardboard wrapped pair

CUSTOM METAL FENDERS

Custom Sizes

- Determine curving dimensions using illustration models
- Available for all metal fenders except smooth, radiused
- Mounting brackets and installation hardware available separately



LIKE IT? CUSTOMIZE IT!

RIGHT HERE!



SINGLE AXLE

A (Overall Length) = _____ in inches

B (Opening) = _____ in inches



HALF TANDEM

A (Front Curve) = _____ in inches

B (Flat) = _____ in inches



FULL TANDEM

A (Front Curve) = _____ in inches

B (Flat) = _____ in inches

C (Rear Curve) = _____ in inches

FENDER MEASUREMENTS GUIDE

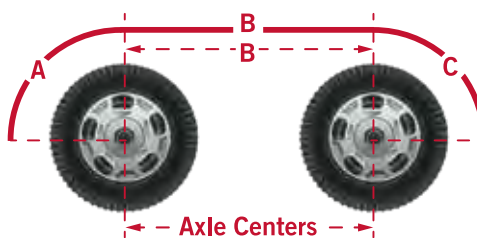
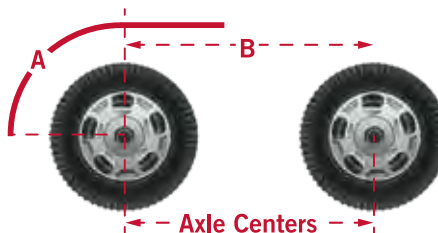
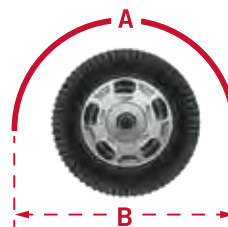

CUSTOM QUARTER FENDERS

Etched Monograms

- Select from three stock monograms
- Customize with any print-ready artwork
- No set up charge
- No minimum; one truck or your entire fleet
- Service limited to stainless steel quarter and 2-Rib tandem fenders



SMART™

TOP FLAP OPTIONS
SEE PAGE 23

Top Flaps

- OEM logo top flaps available on all quarter fenders
- Customize with any print-ready artwork
- Minimum order quantities and set up charges may apply



CUSTOM POLY FENDERS

- Custom colors available
- Minimum order quantities apply
- Additional lead time required
- Available for 16.5", 19.5", 22.5" and 24.5" wheel application



LIKE IT? CUSTOMIZE IT!

To specify your custom order project, contact BettsHD Customer Support by phone at 800.227.2192 or via email at Customer.Support@BettsHD.com.

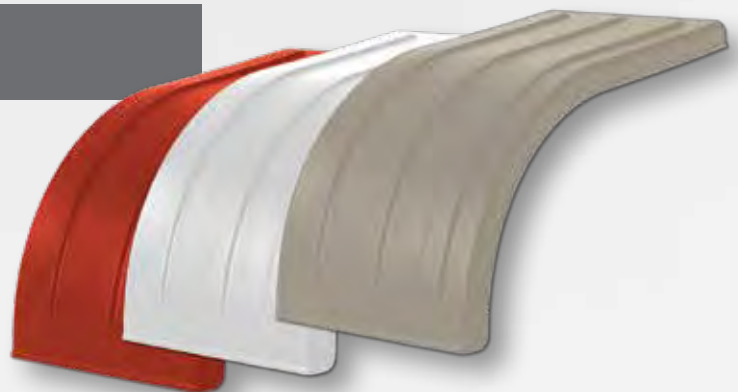

Smart™ Part Numbering System Use the chart below to determine the appropriate part number for your application. A value from each column is required, but not all combinations are valid part numbers.

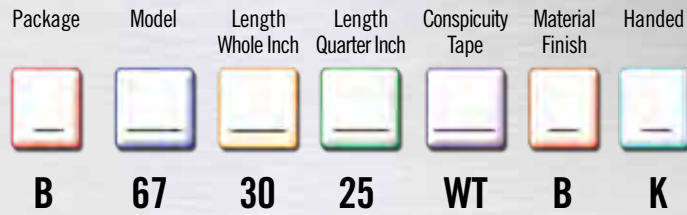

Example –

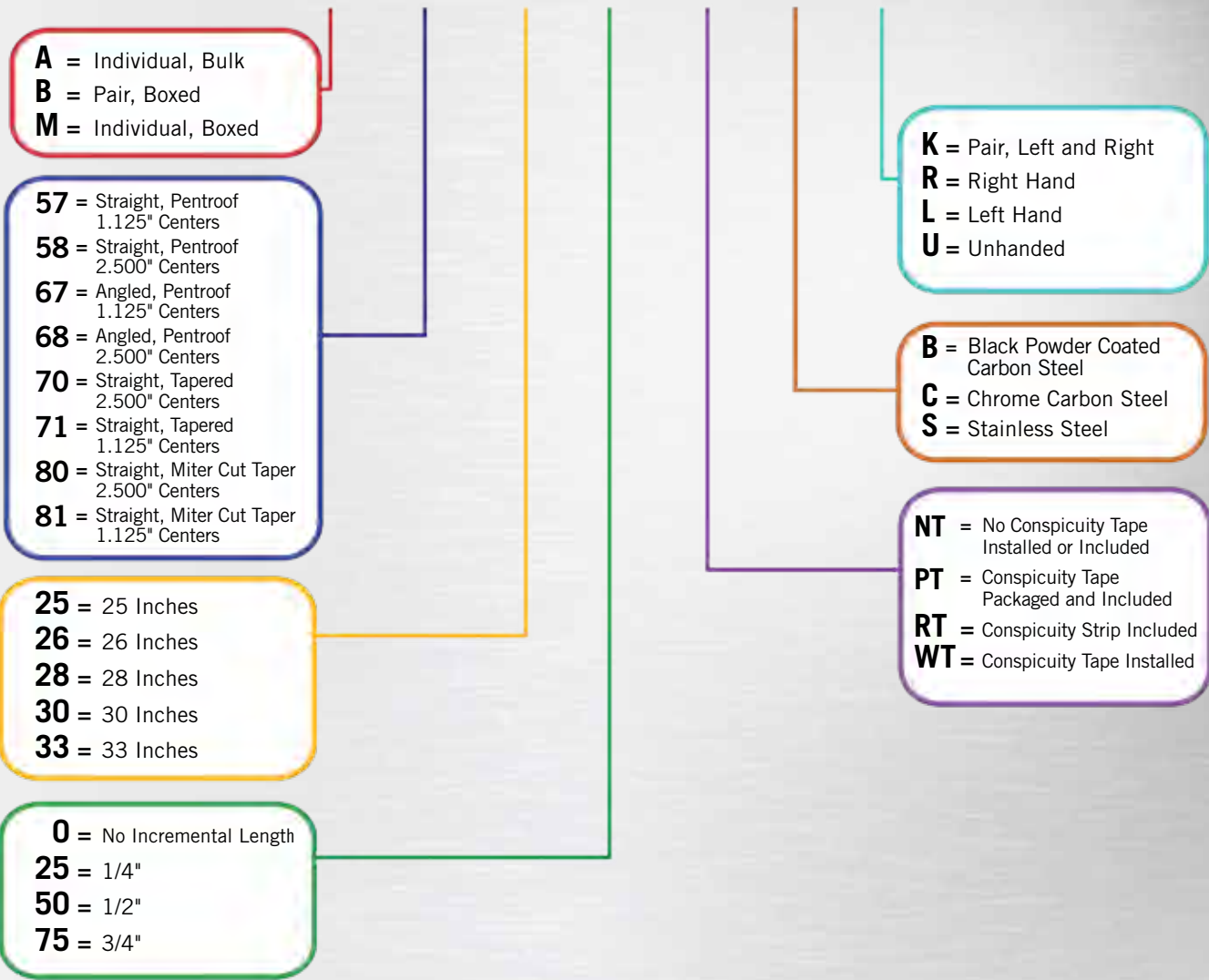

Smart™ Part Numbering System Use the chart below to determine the appropriate part number for your application. A value from each column is required, but not all combinations are valid part numbers.

Material Model Family Position Mount Top Flap Package



Example –

P S 2 1 1 PA 2

- A** = Aluminum, Mill Finish, .090"
- B** = Carbon Steel, E-Coat, 18 Gauge
- P** = Poly
- S** = Stainless Steel, Bright Finish, 18 Gauge
- T** = Stainless Steel, Bright Finish, 16 Gauge

- S** = Smooth
- T** = Triangle

- 1** = Quarter Fender, U-Bolt Mount
- 2** = Quarter Fender, Cradle Mount

- 1** = Standard Mount
- 2** = Low Mount
- 3** = No Mount, Undrilled

- 1** = No Mount
- 2** = One Bolt Post Mount
- 3** = Four Bolt Flange Mount
- 4** = Crossover Mount
- 5** = Four Bolt Flange Mount, Kenworth

- 1** = Pair, Assembled, Top Flaps Installed
- 2** = Pair, Assembled, Top Flaps and Hardware Included
- 3** = Right Hand, Assembled, Top Flaps Installed
- 4** = Left Hand, Assembled, Top Flaps Installed
- 5** = Right Hand, Assembled, Top Flaps and Hardware Included
- 6** = Left Hand, Assembled, Top Flaps and Hardware Included
- 7** = Individual, Unassembled, Top Flap and Hardware Included
- 8** = Pair, Assembled, Top Flaps and Hardware Not Included
- 9** = Individual, Unassembled, Top Flap and Hardware Not Included

- EG** = White Poly, Red-Blue Silver Eagle Logo
- FA** = White Poly, Black Freightliner Logo
- FD** = White Poly, Blue Ford Logo
- FL** = Black Poly, White Freightliner Logo
- FM** = Black Poly, Red-Orange Flame Logo
- KW** = White Poly, Red Kenworth Logo
- LH** = Black Poly, Silver Longhorn Logo
- MA** = White Poly, Black Mack Logo
- MC** = Gray Poly, Black Mack Logo

- MK** = Black Poly, Silver Mack Logo
- NT** = Black Poly, Orange-Silver International Logo
- PA** = Black Poly, No Logo
- PT** = White Poly, Red Peterbilt Logo
- PU** = Black Poly, Red Peterbilt Logo
- PW** = White Poly, No Logo
- RA** = Sheet Rubber, No Logo
- TG** = White Poly, Black Sterling Logo
- VL** = White Poly, Blue Volvo Logo
- WC** = White Poly, White-Crimson Western Star Logo
- WS** = Black Poly, White-Crimson Western Star Logo

Smart™ Part Numbering System Use the chart below to determine the appropriate part number for your application. A value from each column is required, but not all combinations are valid part numbers.

KITS

Example –



K = Kit, Pair
H = Kit, Individual

2 = Single Axle
3 = Half Tandem
4 = Full Tandem

2 = 26.5" Tube
3 = 30.0" Tube

6 = .625" Hole
7 = .750" Hole

G = Galvanized
S = Stainless

P = Predrilled
U = Undrilled

2 = Carriage Bolts (5)
3 = U-Bolts (3)
4 = U-Bolts (4)

TUBES

Example –



T = Tube, Mount

2 = 26.5" Tube
3 = 30.0" Tube

6 = .625" Hole
7 = .750" Hole

G = Galvanized
S = Stainless

P = Predrilled
U = Undrilled

2 = Carriage Bolts (5)
3 = U-Bolts (3)
4 = U-Bolts (4)

Parts, Service and Support for the Long Haul



Product Index:

Superior customer support

Toll free – 800.227.2192
8:00 AM – 8:00 PM Eastern Time

Two strategic stocking locations

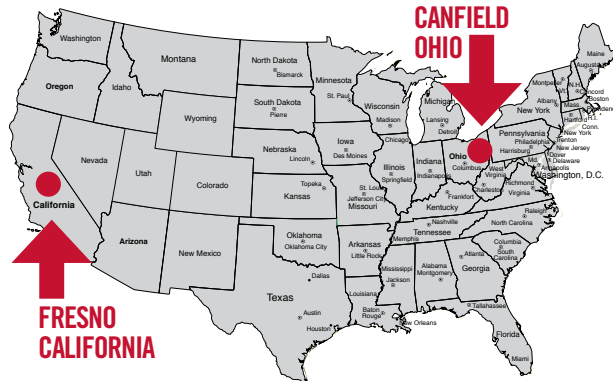

Supporting you in the marketplace and at the point of sale.

BettsHD is your partner in profitability. We support the efforts of our distributors through print campaigns, POS signage, media relations and an interesting and informative website at BettsHD.com.



400118-00	13	PF200-68	14
400118-01	13, 19	PS211PA2	12
A25RL	2	PS221PA2	12
A25RL40	2	PF300-66	14
A25RL90	2	PF40	15
A35RL	4	PF400-132X	14
A35RL40	4	PF400H-1	15
A35RL80	4	PF51	15
B1732	6	RT25	7
B23	3	RT25RL	7
B25	3	RT35	7
B33	5	RT35L	7
B35	5	RT35R	7
B4H-1	15	SF100H	16
B4HS-1	17, 19	SF200H	18
B516P	6	SR200-80	16
B573025WTBK	8	SR300-66	16
B610TS	19	SR400-126	16
B672625NTBK	9	SS211PA2	12
B673025WTBK	9	SS221PA2	12
B700	6	T362PS	17
B7030000NTSK	8	T362US	17
B711	6	T363UG	15
B81	5	TIKPF200-68P	14
B82	3	TIKPF300-66P	14
B83	3	TIKPF400-132XP	14
B84	5	TIKSR300-66DS	16
B850	6	TIKSR400-126DS	16
B87	5	TIKT392700	18
B900G	15	TIKT395439	18
B900S	17, 19	TIKT800000	18
CF25RL30PB	11	TS100H-1	19
CF3526LH24PB	11	TS33902700	18
CF3526RH24PB	11	TS43905439	18
CP12	15, 17	TS8000000	18
DF25PB941	10	TS80100139	19
DF3526PB941	10	TS80100141	19
K2362PS	16, 17	TSG100-1	19
K2363UG	14, 15	U300TS	18, 19
K3362PS	16, 17	U400TS	18, 19
K3363UG	14, 15	X2900	13, 19
K4362PS	16, 17	Custom Products	
K4363UG	14, 15	METAL FENDERS	20
L200TS	18, 19	POLY FENDERS	21
P100H-1	15	QUARTER FENDERS	21
P4H-1	15	TOP FLAPS	13, 21



BettsHD[®]

2843 South Maple Avenue
Fresno, CA 93725

800.227.2192

Customer.Support@BettsHD.com

Follow BettsHD On Social Media



BettsHD.com

A Valued Member of



BettsCompany[®]

Improving the Way Things Move[®] Since 1868